

SAFETY IS POWER

HARDLOCK[®]

Register of International Marks

APPLICATIONS

Self-Locking Nut

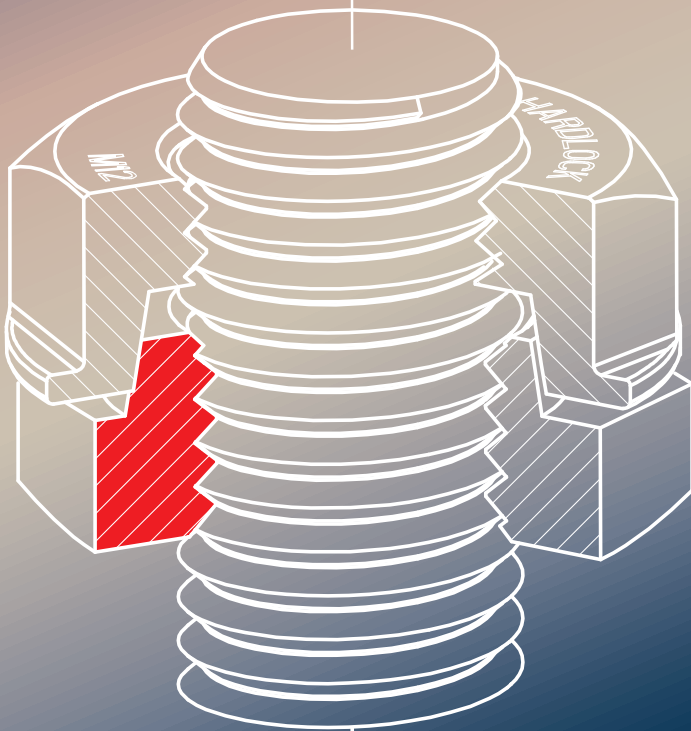

HARDLOCK Industry Co., Ltd.



HARDLOCK Nut (HLN)

- Safety is Power! The Worlds Strongest Self-locking Nut!
- From Industrial Machinery, Mining Equipment to Bridges and Railways, 100% corresponding to the needs of a variety of fields.

The Globally Recognized HARDLOCK Nut

Utilizing the wedge principle used in ancient Japanese architecture, the HLN is the ultimate self-locking nut which perfectly succeeds to integrate the nuts with the bolt.



[MAIN FEATURES]

- **Self-locking Effect Recognized by the World!**
HARDLOCK Nut also passed the United States NAS (National Aerospace Standard) Aviation Standards.
- **Enables Torque and Axial Force Control!**
Controlling axial force with proper torque wherever it is used.
- **Reusable!**
All metal with little abrasion, sustains a high self-locking effect.
- **Excellent and Simple Workability!**
Easy installation with commercially available tools.
- **Provides Substantial Cost Savings!**
Allows significant reduction in total cost by reducing maintenance costs, labor costs etc.



Self-locking Design

The design is based on the traditional Japanese "Wedge" principle!

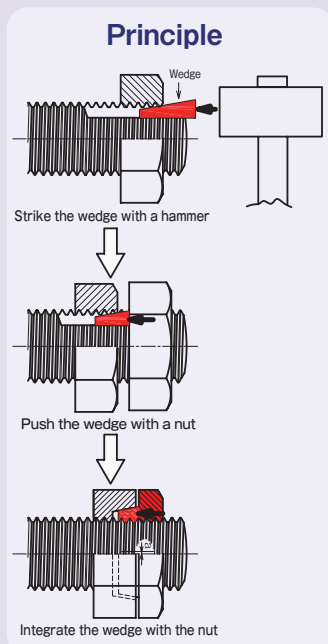

- 1** HARDLOCK NUT consists of two nuts, the (1) nut "Convex Nut" (fixing nut) has a truncated protrusion arranged off-center on the upper part, the (2) nut "Concave Nut" (locking nut) is designed with a concentric conical depression for locking the two nuts together. By tightening the concave nut onto the convex nut, a strong perpendicular load will be applied to the bolt from both sides.

Source of the locking effect!

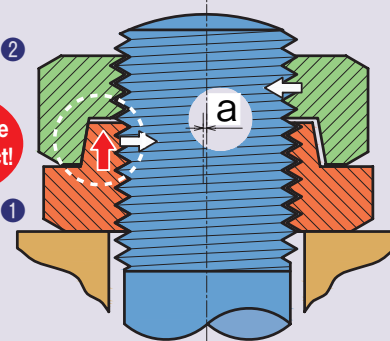

- 2** Due to the strong locking force created by the Wedge of the HARDLOCK NUT, no matter if it is exposed to severe vibrations and/or impacts the HARDLOCK NUT will stay intact

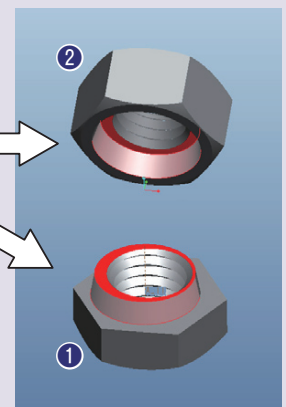
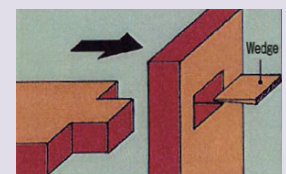

Installation Procedure



1 Install the Convex Nut (Fixing Nut) to the fitting member manually, by hand.



2 Use a tightening tool (Spanner, Torque Wrench etc.) to tighten the Convex Nut to the appropriate torque required for the application.



3 At this point, the Convex Nut has exactly the same strength as a general-purpose nut.



4 Install the Concave Nut onto the Convex Nut by hand. make sure that the space between the 2 nuts is about 1 thread pitch.



5 Use a torque wrench to tighten the Concave Nut to the torque value set by HARDLOCK Industry Co., Ltd. Or about 1 turn with a spanner.

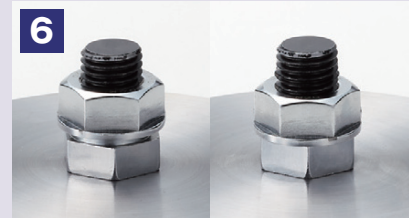

6 After installing, a gap may occur due to the bolts tolerance class. However, if tightened correctly by following the installation procedure, the HLN will produce a sufficient locking effect.

Attention

Torque and Axial Force Control is only possible with the HARDLOCK Nut!

HARDLOCK Nut is not affected by external vibration impact whatsoever, and allows torque and axial force control under very severe conditions.

The Concave Nut will completely lock the Convex nut in the state and maintain the torque and axial force which it was initially installed with even if their value was low.

① Superior Self-locking effect ② Torque & Axial force control ③ Re-usability. The ultimate self-locking nut with these features is only the HARDLOCK Nut.

Testing

Impact Vibration Test Complying to NAS 3350/3354

TEST SAMPLE CONDITIONS

Size M12x1.75
Material SS400
Finish Trivalent Chromate
Torque 40 Nm

Vibration frequency 1,780c.p.m
Vibration stroke 11mm
Impact stroke 19mm
Accelerated vibration 19.5Ga

No loosening
Test aborted
Vibration Time 1020 sec (17 min)

Loosening Time 360 sec

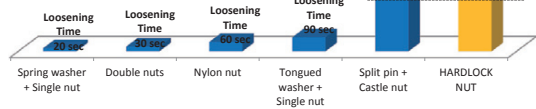

Junker Test

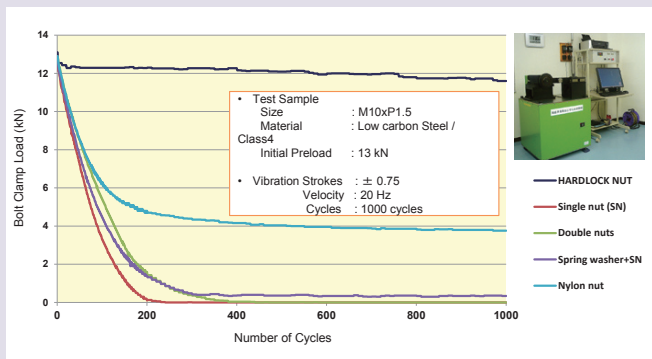

Total Cost Comparison (Certain Railway Company)

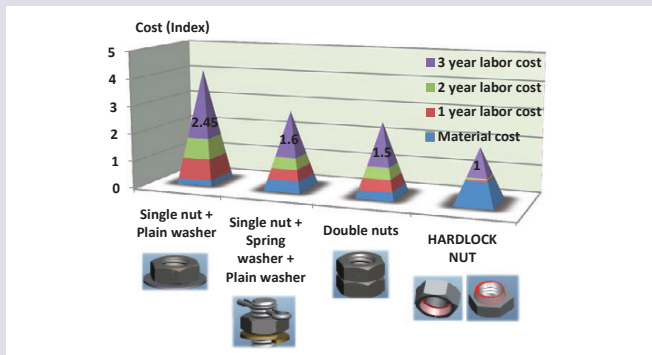

COMPANY OUTLINE

COMPANY NAME	HARDLOCK INDUSTRY CO., LTD.
ESTABLISHED	April, 1974
PAID IN CAPITAL	JPY 10 million
ANNUAL TURNOVER	JPY 1.5 billion
DIRECTOR	Katsuhiko Wakabayashi
NUMBER OF EMPLOYEES	70
HEAD OFFICE	1-6-24, Kawamata, Higashi-Osaka, Osaka, Japan 577-0063
TOKYO BRANCH	3F, Higashi-Ueno Sanwa Building, 2-5-9, Higashi Ueno, Taito, Japan 110-0015
OVERSEAS DISTRIBUTORS	6 countries
MAIN LINES OF BUSINESS	<p>Manufacture and sale of the self-locking products.</p> <p>HLN : HARDLOCK NUT HLB : HARDLOCK BEARING NUT HLS : HARDLOCK SET SCREW * All products patented</p>
CERTIFICATE	<p>JIS Q9100 : 2009 (AS 9100) ISO 9001 : 2008 (JIS Q 9001 : 2008)</p>
MAIN USERS	<p>【Domestic】 East Japan Railway Company Central Japan Railway Company West Japan Railway Company Kawasaki Heavy Industries, Ltd. Mitsubishi Heavy Industries, Ltd. Hitachi, Ltd. TOSHIBA CORPORATION IHI Corporation NIPPON STEEL & SUMITOMO METAL CORPORATION JFE Steel Corporation Kobe Steel, Ltd.</p> <p>【Overseas】 China Railway High-speed (China) Network Rail (UK) Taiwan High Speed Rail (Taiwan) Queensland Rail (Australia) Hyundai Rotem (Korea) POSCO (Korea) HOERBIGER (Austria) Vale (Brasil) Anglo American (Brasil) Samarco (Brasil)</p>

COMPANY HISTORY

- Apr. 1974 HARDLOCK Industry Co., Ltd. was established in Nagata, Joto-ku, Osaka. Manufacturing and Sales of the HARDLOCK Nut was commenced.
- Oct. 1980 A UK Market distributor for the HARDLOCK Industry Co., Ltd. was established.
- Apr. 1985 The HARDLOCK Nut was adopted in the Tokaido Shinkansen 100-series cars.
- Jun. 1992 HARDLOCK Industry Co., Ltd. was requested by Hitachi Ltd. to manufacture HARDLOCK Nuts for adopting in their heavy electrical machinery in a certified nuclear power plant.
- Oct, 2000 Due to demands for the HARDLOCK Nut overseas, the foreign trade department was established.
- Mar. 2003 4 million units of HARDLOCK Nut was adopted in various locations in the Taiwan high-speed rail.
- Sept. 2003 Distributor for the Korean market was established in Seoul.
- Oct. 2003 HARDLOCK Industry Co., Ltd. acquired certification for rail tracks in the UK railway of Network Rail.
- Nov. 2003 Acquired certification ISO9001: 2000 from the German Organization TÜV.
- Dec. 2003 Acquired certification for railway in Queensland and Victoria, Australia. (Certification Number : C0054)
- Jul. 2005 Announce research thesis on HARDLOCK Nut locking effect at ASME PVP 2005.
- Dec. 2006 BBC channel 1 introduces the effectiveness of HARDLOCK Nut loosening in a program on railway accidents, leading to increased use in the railway industry.
- Sept. 2011 Received JISQ 9100 : 2009 certification for Quality Management Systems in the aerospace and defense industries.
- Mar. 2014 The HARDLOCK Nut was officially adopted by Vale S.A. in Brasil to increase safety and workability in the Mining and Earth Moving industry.



REQUIREMENT	DESCRIPTION	UNIT	MINIMUM	MAXIMUM	REFERENCE
1	RELAT 101-01	Hardlock Nut			Hardlock Nut
2		Hardlock Nut			Hardlock Nut
3		Hardlock Nut			Hardlock Nut
4		Hardlock Nut			Hardlock Nut
5		Hardlock Nut			Hardlock Nut
6		Hardlock Nut			Hardlock Nut
7		Hardlock Nut			Hardlock Nut
8		Hardlock Nut			Hardlock Nut
9		Hardlock Nut			Hardlock Nut
10		Hardlock Nut			Hardlock Nut

1 ENERGY / POWER



[MAIN APPLICATIONS]

- **Wind Power**
Power Generator · Decelerator
Cable Racks in Turbine Towers Etc.
- **Solar Power**
Solar Panel Mounting Etc.
- **Thermal Power Generation**
Desulfurization Equipment
Hopper Liner Stops · Bucket Conveyors Etc.
- **Nuclear Power**
Power Plant Instrumentation · Piping
Reactor Filtration Machine
Nuclear Reactor Control Mounting Etc.



Wind Turbine Tower



Dam



Thermal Power Plant



Wind Turbine Tower Internal Piping

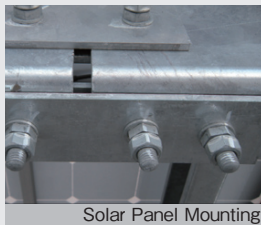

Solar Panel Mounting



Solar Power



Nuclear Power Plant

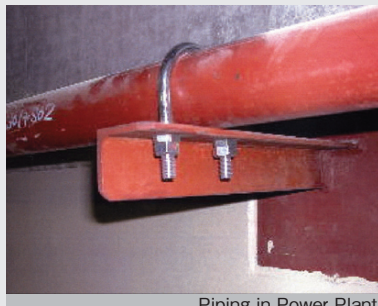

Piping in Power Plant

2 MINING & EARTH MOVING

HLN

[MAIN APPLICATIONS]

● **Processing Machinery**

- Vibrating Screen
- Breaker
- Conveyer System
- Grid Car

● **Heavy Machinery**

- Off-Road Truck
- Dozer
- Bucket Wheel Excavator

● **Freight Railway**

- Wagon
- Wagon Rotator
- Fishplate
- Crossing



Pendulum securing



Coupling fastening



Bucket securing



Caterpillar treads securing

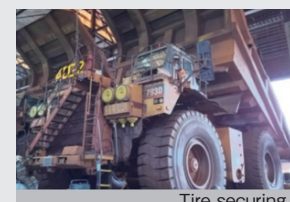

Tire securing

3 RAILWAY (ROLLING STOCK)



[MAIN APPLICATIONS]

- Shinkansen (Bullet Train) / Conventional Trains / Monorail
- Various Equipment Mounting for Trains
- Various Control Device Mounting
- Bearing Box
- Tight Coupler
- Disc Break
- Drive Unit Coupling Portion
- Suspension / Hydraulic Damper Portion
- Automatic Door Unit Etc.



Shinkansen E5 Series (Bullet Train)



Shinkansen N700 (Bullet Train)



Taiwan Shinkansen 700T (Bullet Train)



UK Express 395 Series



New Transport System

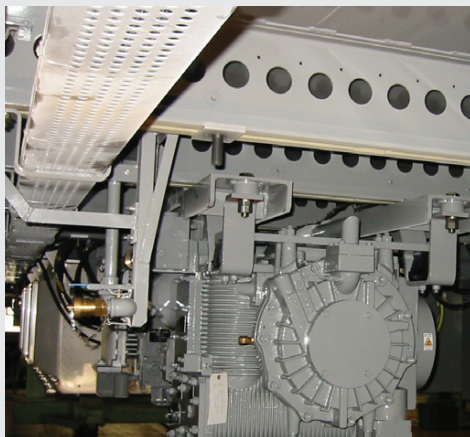

Shinkansen Equipment Mounting



Tight Coupler

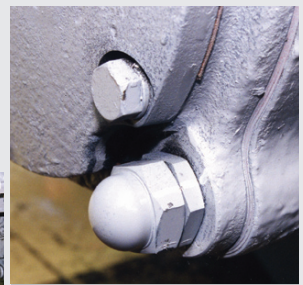

Bearing Box

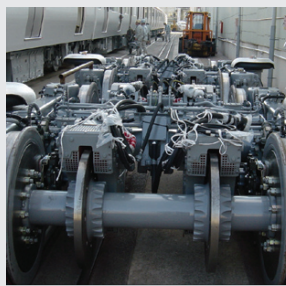

Various Mounting for Carriage Section



Disc Break

4 RAILWAY (INFRASTRUCTURE)



[MAIN APPLICATIONS]

- **Railway (Power)**
Steel Column Flange Stop
Stationary Beam
Overhead Line Bracket · Band
Etc.
- **Railway (Signal)**
Automatic Train Stop (ATS)
Impedance Bond
Railroad Switch Moving Portion
Control Equipment Box in Terminal
Etc.
- **Railway (Track)**
Rail Joint / Insulation Seam Bolt
Splinter with Various Bolts
Rail Fastening Device
Derailment Prevention Guard
Etc.
- **Railway (Construction)**
Railway Station Equipment
Station Building Roof
Shinkansen / Conventional
Line Soundproof Wall Etc.



Steel Column Flange Stop



Beam and Movable Bracket Band Stop



Automatic Train Stop (ATS)

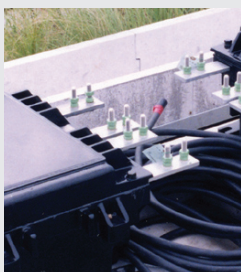

Impedance Bond



Terminal Attachment



Derailment Preventive Guard



Rail Joint



Fish Plate

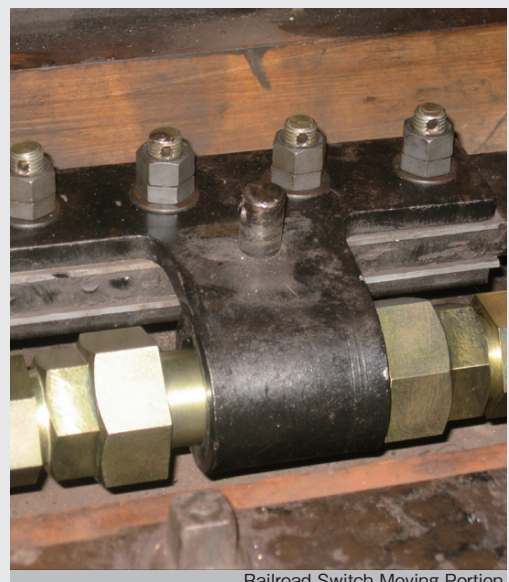

Railroad Switch Moving Portion

5 BRIDGE



[MAIN APPLICATIONS]

- Bridge Ancillary Equipment Joint Portion
- Piping Flange Portion
- Inspection Passage
- Long-span Bridge Illumination Equipment
- Maintenance Vehicle Equipment for Inspection
- Information Board
- Pedestrian Bridge
- Falling Objects Prevention Equipment
- General Road Equipment



Water Supply Plumbing (Akashi Kaikyo Bridge)



Long-span Bridge Ancillary Equipment Joint



Long-span Bridge Road Equipment

6 HIGHWAY

HLN

[MAIN APPLICATIONS]

- Road Joints
- Soundproof Wall Joint
- Sound-absorbing Panels
- Illuminating Equipment and Base Plate
- Direction Board
- Jet Fan in Tunnels
- Grating Joint
- Guard Rail Joint
- ETC (Electronic Toll Collection) Board · Information Board
- Storm Drain Cover Securing



Various Soundproof Walls

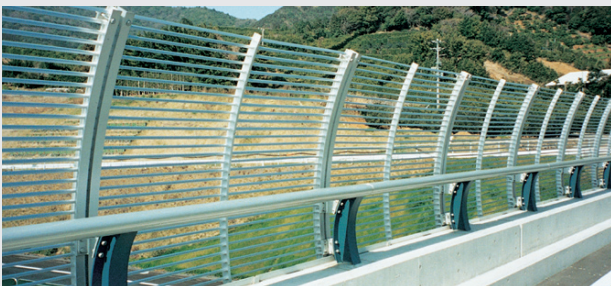

Aluminum Highway Fence (Second Tomei Expressway)



Lighting Columns Anchor Portion (Metropolitan Expressway)

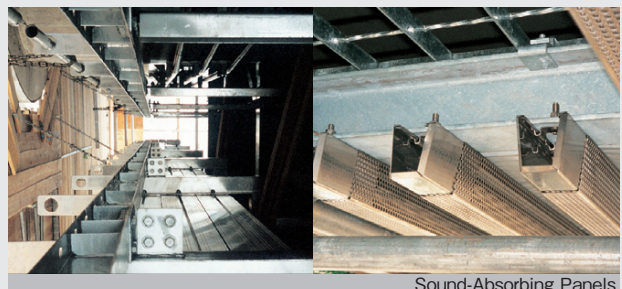

Sound-Absorbing Panels

7 VEHICLES



[MAIN APPLICATIONS]

- **Specially Equipped Vehicle**
 Engine Transmission
 Damper & Trunnion
 Frame Bracket Mounting
 Etc.
- **Buggy**
 Wheel Axle Sprocket Stopper
 Engine starter Etc.
- **Ship**
 Internal Combustion Engine System
 Inboard Hydraulic Tube Flange
 Etc.
- **Amusement Ride**
 Roller Coaster Wheel Axis
 Rail Joint
 Coaster Sheet Joint
- **Transport Equipment**
 Forklift Wheel Axis Portion
 Etc.



Specially Equipped Vehicle



Buggy



Sprocket Stopper



Frame Mounting

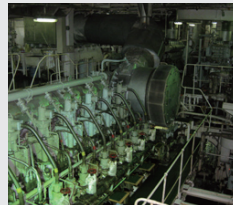

Ship Engine



LNG Ship



Concrete Pump Truck



Forklift



Guide Roller

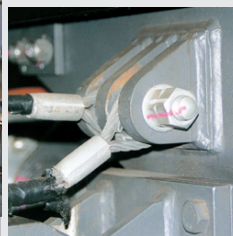

Wheel Axis Stopper

8 MACHINERY



[MAIN APPLICATIONS]

- Cement Mill (Liner Stopper)
- Concrete Mixer (Decelerator)
- Power Cylinder (Drive Shaft Stopper)
- Excavator (Drill Drive Shaft Stopper)
- Rock Drilling Machine (Hydraulic Breaker Stopper)
- Agitator (Impeller Stopper)
- Large Hydraulic Press (Cylinder Unit, Etc.)
- Compressor (Axis Stopper)
- Pump (Impeller Stopper)
- Tapping Machine (Ball Screw)
- Injection Molding Machine
- Steel Making Machinery (Straightening Roll Stopper)
- Conveyor Rollers
- Industrial Robot Arm Portion
- Die-casting Machine (Core Pin Stopper)
- Etc.



Injection Molding Machine

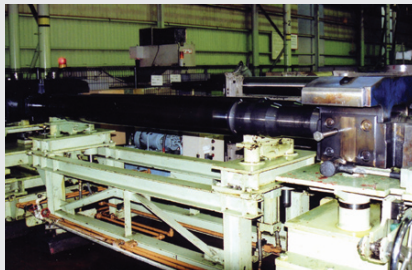

Steel Making Machinery (Straightening Roll Stopper)



Excavator

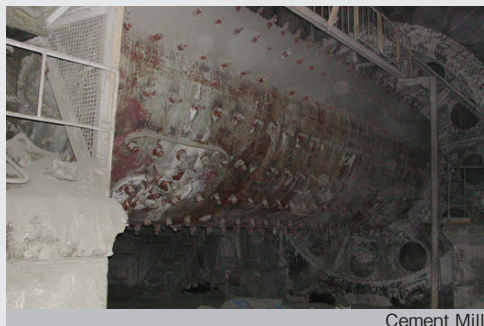

Cement Mill



Hydraulic Breaker Tie Rod Stopper

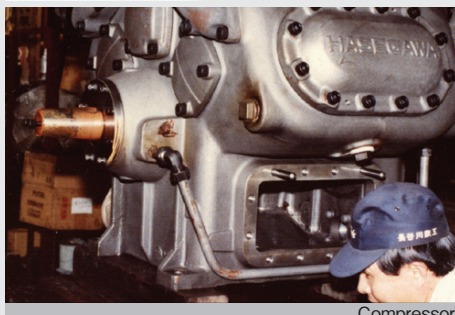

Compressor

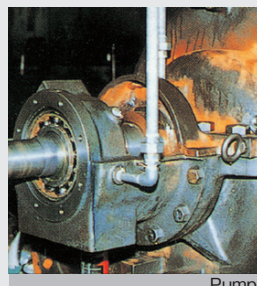

Pump

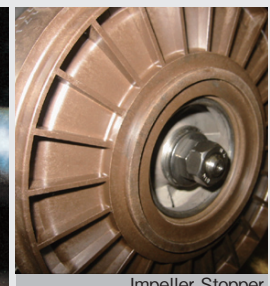
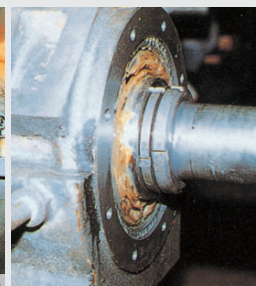

Impeller Stopper

9 Construction



[MAIN APPLICATIONS]

- High-rise Building Bonding Portion
- High-rise Building Ancillary Equipment
- High-rise Building Curtain Wall Portion
- Exterior Wall (Panel) Mounting
- Turnbuckle
- Dome Steel Frame Joint
- Stone Wall Pitching
- Facility Roofing
- Top Light Fastening
- Sanitation & Electrical Equipment Etc.



High-Rise Building Exterior Wall & Curtain Wall



Tokyo Sky Tree



Metal Frame Joint

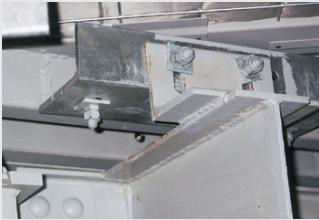

Yurikamome Station Roof



Osaka Station Renewal

10 PYLONS

HLN

[MAIN APPLICATIONS]

- **Communication Towers**
Steel Tower Connecting Portion
General Ancillary Equipment
Digital Frame Mounting
Etc.

- **Transmission Tower**
Steel Tower Connection Portion
Pipe Jumper Part
Insulators Fastening Portion
Etc.



Transmission Tower



Communication Tower



Transmission Line Tower Pipe Jumper



Joint (Angle/Pipe)



Joint (Angle/Pipe)



Communication Tower Digital Frame Portion



1. Car & Motorcycle



HLN SUV Engine Transmission

Before

- Flanged Nuts were utilized in the engine transmissions of SUVs
- Loosening of nuts occurred frequently when starting the engine and many SUVs had to be recalled.

After

- By switching from Flanged Nuts to HARDLOCK Nuts the loosening problem was resolved.
- By utilizing HARDLOCK Nut the loosening occurring when starting the engine were also resolved.

Major Loosening Cause

- Loosening due to cyclic stress in the rotational direction of the bolts axis

2. Specially Equipped Vehicle



HLB Specially equipped vehicle trunnion fixing

Before

- Double bearing nuts were used as a countermeasure for loosening
- The double bearing nuts were tightened by the "double nut method". However, loosening occurred due to the variation in tightening force.

After

- By adopting the HARDLOCK Bearing Nut, the workability was improved and the loosening problem was solved.
- By switching to HARDLOCK Nut, the maintenance costs were significantly reduced

Major Loosening Cause

- Loosening due to cyclic stress in the rotational direction of the bolt axis

3. Construction machinery and agriculture machinery

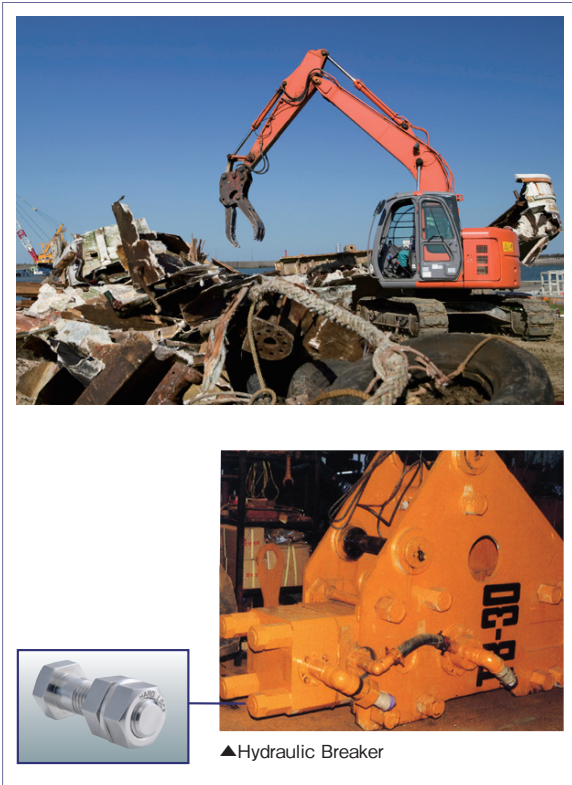

HLN Hydraulic Breaker

Before

- Loosening caused by severe impact vibration from crushing operations at mines and large quarries occurred on a regular basis. Double nuts were used and carried out a high-torque fastening and dropout prevention measures, but the problem was not solved.

After

- By introducing HARDLOCK Nut, axial force management by proper torque and loosening prevention was achieved

Major Loosening Cause

- Loosening due to cyclic stress in the direction perpendicular of the bolts axis

4. Robot



HLB Industrial Robot Arm Joint

Before

- Prevailing torque type self-locking nuts where used were in the arm portion, but iron powder produced by the friction between the nut and shaft caused poor movability.
- Torque control was difficult with prevailing torque type self-locking nuts and there was a problem with variety in axial force.

After

- By switching to HARDLOCK Bearing Nut the problem with shaft damage was resolved.
- Axial force management by proper torque combined with elimination of loosening improved the product performance of the industrial robots.

Major Loosening Cause

- Loosening due to cyclic stress in the rotational direction of the bolt axis

5. Conveyance Equipment

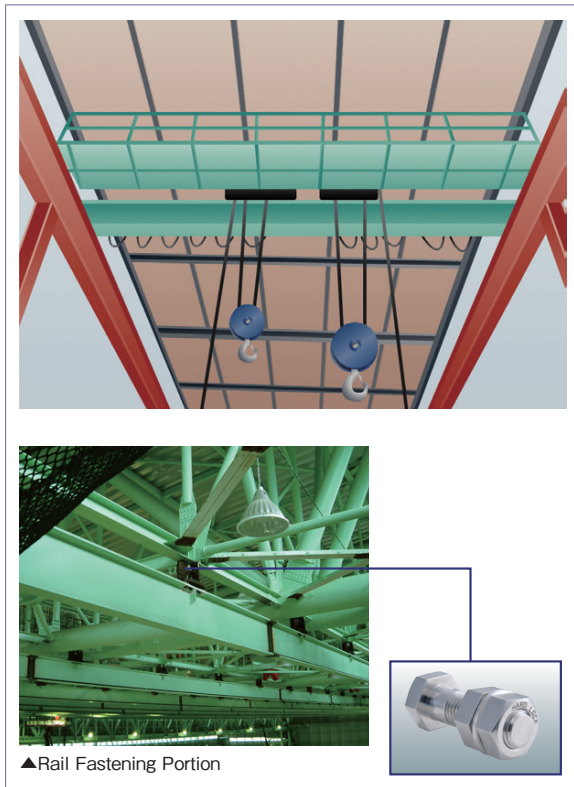

HLN Indoor Overhead / Bridge Cranes

Before

- Prevailing torque nuts were used for indoor overhead cranes. However, due to excessive vibration loads they became loose on a regular basis.
- Due to the everyday loosening, re-tightening works etc., maintenance cost was increased immensely.

After

- By changing to HARDLOCK Nuts, loosening in the fastening portions of the cranes was eliminated.
- As a result, stable operations and reduction in maintenance work lead to significant cost savings.

Major Loosening Cause

- Loosening due to cyclic stress in the direction perpendicular of the bolt axis

6. Iron & Steel

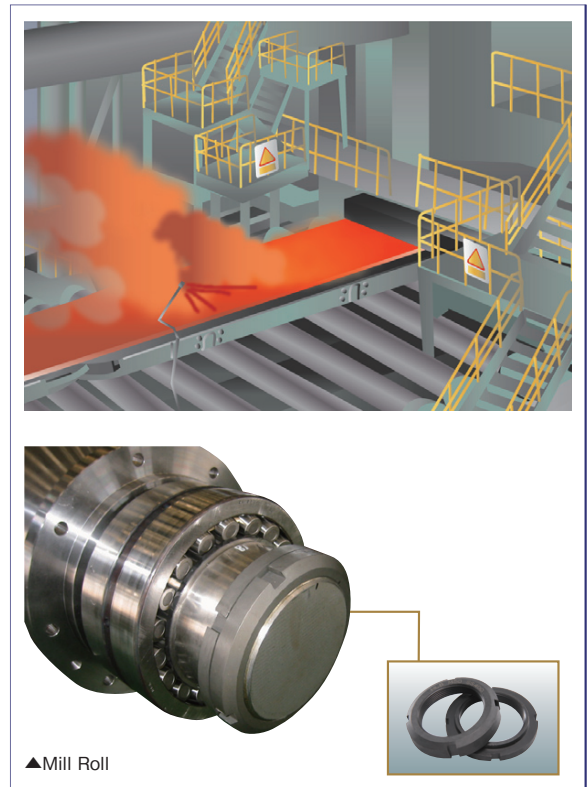

HLB Steelwork Equipment Lines

Before

- To prevent loosening at steelwork equipment lines, the shafts has key grooves and is fastened with both toothed washers and nuts as well as welding in some instances.
- In recent years, steelwork facilities are continuing with a fire-free work environment. Therefore, welding and such other procedures have been minimized.

After

- When using HARDLOCK Bearing nuts, it eliminates the need to use toothed washers, key grooves and welding procedures, significantly improving the workability.
- Eliminating the need for welding procedures, the HARDLOCK products creates a safe, fire-free work environment.

Major Loosening Causes

- Loosening due to cyclic stress in the rotational direction of the bolt axis
- Loosening due to cyclic stress in the direction perpendicular of the bolt axis

7. Industrial machinery

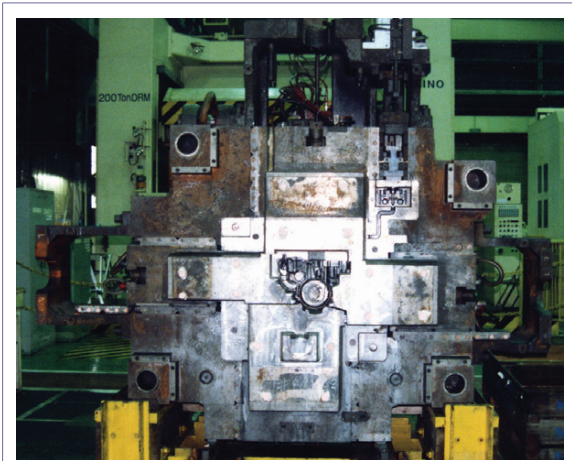

▲Die-cast Machine

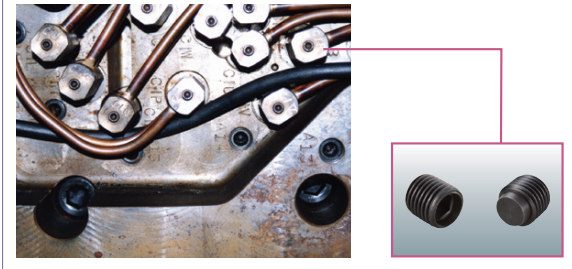

HLS Die-Casting Core Pin Stopper

Before

- Conventionally, spot welding, bolt fastening method of plates and nesting method were used to prevent the core pin to recede from the pressure during molding.
- Reduced die strength and work time was a problem with the conventional pin retraction prevention measures.

After

- By switching to HARDLOCK Set Screw, preventing retraction of the core pin was achieved by only tightening the HARDLOCK Set Screw, no other measurements were necessary. It also contributed to reduce molding costs.
- Prior to switching to HARDLOCK Set Screws it took more than 12 hours to replace the core pin, but after switching to HARDLOCK Set Screw, the same work was reduced to approximately 3 hours.

Major Loosening Cause

- Loosening due to cyclic stress in the direction of the bolt axis

8. Fluid Equipment

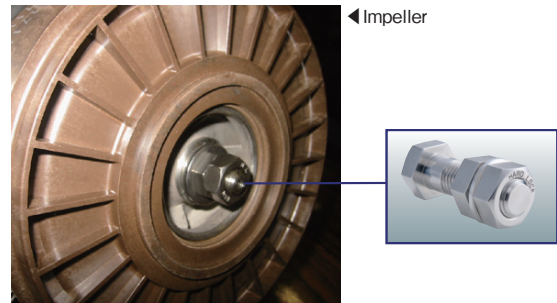
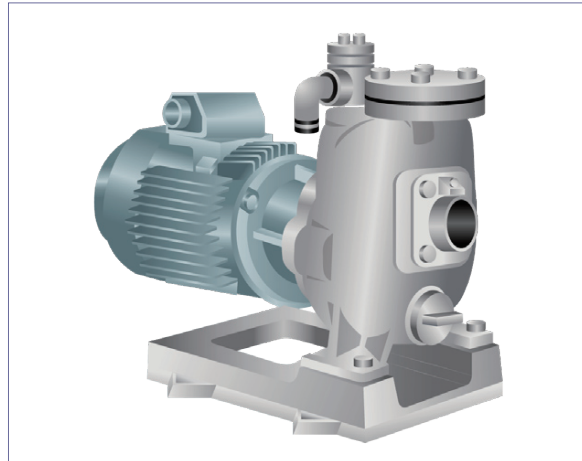

◀Impeller

HLN Impeller Pump

Before

- Vibration in the pump due to high speed rotation in the impeller shaft caused loosening.
- Castellated nuts and other self-locking components were used, but this did not completely resolve loosening.

After

- After switching to HARDLOCK Nut vibration loosening due to high speed rotation was completely eliminated, as well as significant decrease in periodic maintenance costs.
- Switching to HARDLOCK Nut also prolonged the product life.

Major Loosening Cause

- Loosening due to cyclic stress in the rotational direction of the bolt axis

9. Heavy Electrical Plant



▼Piping Support

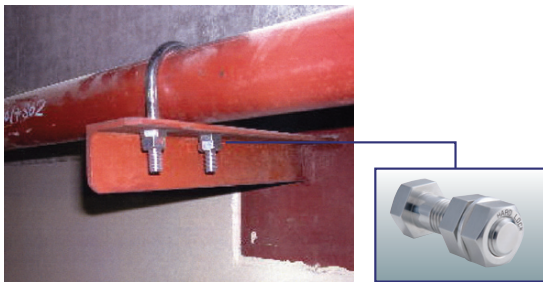

HLN Nuclear Power Plant Reactor Core

Before

- Double nuts were used in the fixed stand of the reactor core and piping supports in the power plant. Retightening work and maintenance were required on a daily basis due to frequent loosening.
- Since nuclear power plants are large in size and places where nuts are used are plenty, huge amounts of maintenance cost and maintenance time was necessary.

After

- HARDLOCK Nut demonstrated superior self-locking performance and prevention of loosening.
- Safety in the nuclear power plant facilities increased, time spent on maintenance and maintenance cost was reduced immensely.

Major Loosening Causes

- Loosening due to micro-motion abrasion
- Loosening due to thermal causes

10. Watercraft



▼Ship Engine

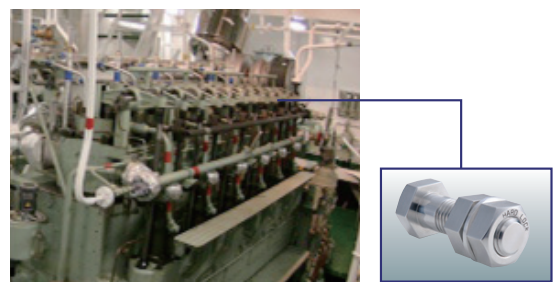

HLN Ship Internal Combustion Engine

Before

- Double nuts were used on the internal combustion engines of the ship, loosening due to thermal expansion and severe vibration occurred on a daily basis.
- Retightening work had to be made frequently and an enormous amount of time and cost was spent on maintenance.

After

- By switching to HARDLOCK Nut with special coating, Loosening due to vibration and/or thermal expansion was eliminated.
- Significant reduction in maintenance cost as well as retightening work.

Major Loosening Causes

- Loosening due to micro-motion abrasion
- Loosening due to cyclic stress in the direction perpendicular to the bolt axis
- Loosening due to thermal expansion

11. Highway / Roads



▲Road Plates



12. Bridge



◀ Pier Cover Plate Mounting



HLN Road Plates Fastening Portion

Before

- Countermeasures such as welding and insertion of cushioning materials to reduce vibration in the road plates were carried out. However, due to poor welding and replacement of cushioning material work, both options were unsatisfactory.
- Another serious problem was the noise control due to collision of the road plates when vehicles passed over them.

After

- By switching to HARDLOCK Nut in the connection portion of the road plates, problems such as loosening were eliminated.
- Additionally, the noise generated when vehicles pass over the road plates was eliminated and overall costs were reduced.

Major Loosening Cause

- Loosening due to cyclic stress in the direction perpendicular to the bolt axis

HLN D Runway expansion D Runway Expansion

Before

- During the construction of the titanium panel on artificial grounds rear surface of the offshore airport, prevailing torque self-locking nuts were studied.
- Since the prevailing torque type self-locking nuts caused scratches on the bolt (peeling off the plating), rust occurrence was a serious problem and concerns regarding safety and corrosion resistance arose.

After

- By switching from prevailing torque type self-locking nuts to HARDLOCK Nuts, problems related to bolt damage and corrosion were eliminated.
- Loosening due to severe vibration in the pier cover plates during landing and take-off of aircrafts were eliminated, HARDLOCK Nut also corresponded to the 100 year warranty requested by the Ministry of Land, Infrastructure and Transport.

Improvement Case

- Loosening due to micro-motion abrasion
- Loosening due to cyclic stress in the direction of the bolt axis

13. Architecture and Construction Equipment

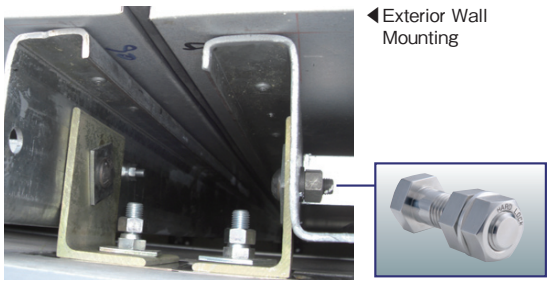

HLN Exterior Wall of High-rise Buildings

Before

- Aluminum curtain walls were mounted on the exterior walls of high-rise buildings with metallic fastener, but due to the high torque required to tighten the metallic fasteners, it caused expansion of the aluminum which would cause a specific sound.

After

- By switching to HARDLOCK Nut, axial force control due to proper torque was achieved and the sound phenomenon was eliminated.

Major Loosening Causes

- Loosening due to cyclic stress in the direction perpendicular to the bolts axis
- Loosening due to thermal causes

14. Electrical Equipment

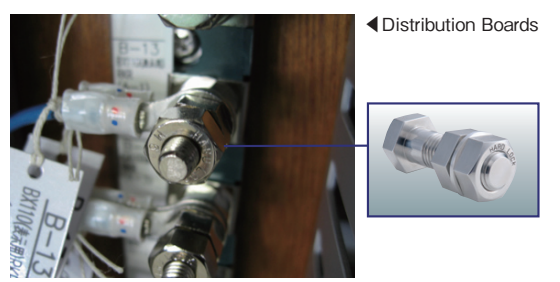
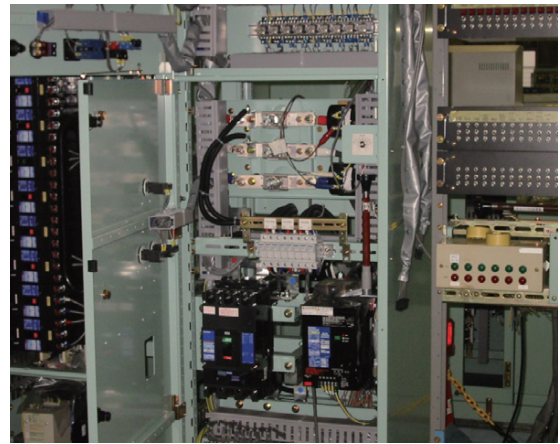

HLN Distribution Board

Before

- Double nuts or spring washer were used, loosening due to vibration caused during product transportation was a regular occurrence.
- Loosening after installation due to micro-vibration during operation occurred on a daily basis.

After

- By switching to HARDLOCK Nut, due to proper torque control, loosening during transportation and/or operation was eliminated.
- Significant savings in labor was achieved due to eliminating re-tightening work.

Major Loosening Cause

- Loosening due to micro-motion abrasion

15. Pylons

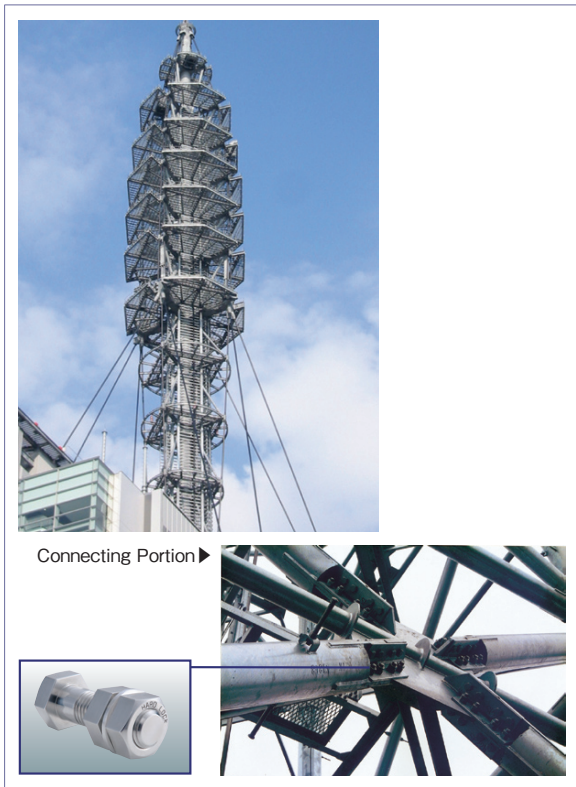

HLN Communication Towers

Before

- Other self-locking double nuts were used in the connection portion in communication towers, however, due to loads generated by wind and vibration that occurs on a daily basis, the axial force was lowered and loosening occurred.
- Re-tightening work from maintenance personal and routine maintenance cost was required to be reduced.

After

- HARDLOCK Nut demonstrated a powerful seismic performance and was therefore replacing previous self-locking nuts and adopted in communication towers.
- By eliminating retightening work and the need for routine torque measurements after switching to HARDLOCK Nut, a significant reduction in maintenance costs was achieved.

Major Loosening Causes

- Loosening due to cyclic stress in the direction perpendicular to the bolt axis
- Loosening due to cyclic stress in the rotational direction of the bolt axis
- Loosening due to excessive external force

16. Environmental Equipment



HLN Transmission Equipment in Wind Turbine Towers

Before

- Wind turbine towers are installed in areas where there are strong winds, due to the irregular stress induced by strong winds, common double nuts and/or spring washers were not able to produce significant locking effect and eliminate loosening.
- Nylon nuts were used in the fastening portions of wiring cable racks, ladders etc. inside of wind turbine towers, however, due to the vibration caused by the rotation of the blades (wings) the Nylon nuts became loose on a regular basis.

After

- By switching to HARDLOCK Nut, due to successful axial force control and proper torque, loosening was eliminated.
- Regular maintenance work and equipment maintenance cost was significantly reduced.

Major Loosening Causes

- Loosening due to cyclic stress in the direction perpendicular to the bolt axis
- Loosening due to micro-motion abrasion

17. Playground / Amusement Park Equipment

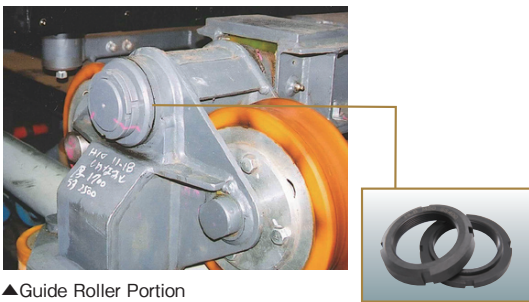

▲Guide Roller Portion

HLB Roller Coaster Wheel Axis Stopper

Before

- Roller coasters and many other attractions use double nuts or split pins for their application. However, due to the hole in the shaft required for the split pin, the shaft's strength is reduced and could end up breaking.

After

- By switching to HARDLOCK Nut, due to successful axial force control the maintenance cost was reduced significantly.
- Additionally, no hole was required in the shaft and the problem with weakened shaft was eliminated.

Major Loosening Causes

- Loosening due to cyclic stress in the rotational direction of the bolt axis
- Loosening due to cyclic stress in the direction of the bolt axis

18. Railway(1)



▼Shinkansen Tight Coupler

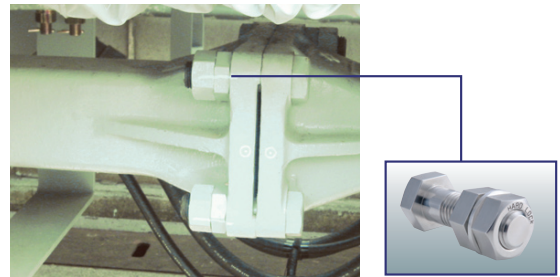

HLN Shinkansen (Bullet Train) Tight Coupler

Before

- In high speed rail cars, repeated impact of the rail coupling causes the nut to loosen and may even risk detachment. Damage to friction ring also causes the nut to loosen.

After

- By using the HARDLOCK Nut, even under repeated impact, loosening is prevented and detachment does not occur. Breakage of the friction ring is eliminated by using the HARDLOCK Nut and has been adopted by many rail car manufacturers.

Major Loosening Causes

- Loosening due to cyclic stress in the direction of the bolt axis
- Loosening due to cyclic stress in the direction perpendicular of the bolt axis

19. Railway(2)

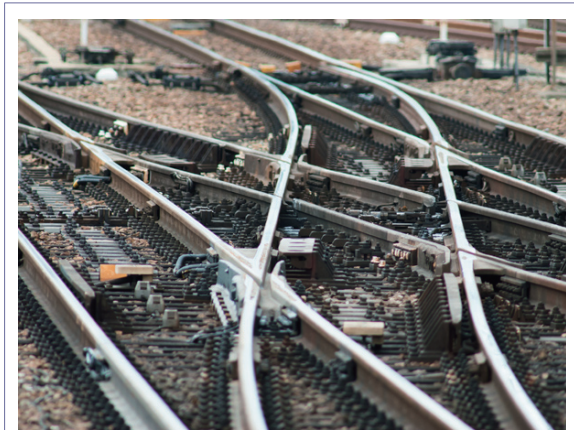

▲Railroad Switch

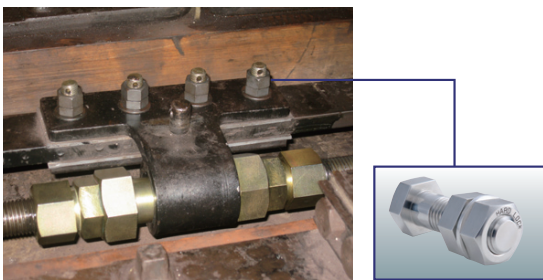

HLN Railroad Switch Switch Adjuster

Before

- When a train passes, a force of 500G is applied to the switch, and even specially shaped double nuts used on the movable parts can become loose on a daily basis.
- While the switch (movable part) is essential to maintain the track gauge, it is extremely difficult to maintain the gauge of the track while preventing loosening.

After

- By using the HARDLOCK Nut, the maintenance cost associated with inspection and re-tightening was successfully reduced.
- The HARDLOCK Nut successfully maintained the gauge of the track and prevents loosening simultaneously. As a result, the HARDLOCK Nut has been adopted by all railway companies in Japan.

Major Loosening Causes

- Loosening due to cyclic stress in the direction of the bolt axis
- Loosening due to cyclic stress in the direction perpendicular of the bolt axis

20. Detached Housing

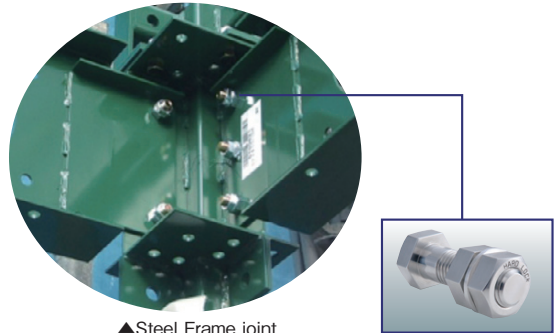

▲Steel Frame joint

HLN Light-gauge steel frame joints for Detached housing

Before

- Conventionally, based on the Building Standards Law, Single Nuts and Spring Washers was going to be used in the Light-gauge Steel Joint as a countermeasure for loosening.

After

- After the Great East Japan Earthquake in 2011, the HARDLOCK Nut usage increased significantly in the Smart House Building Frame Joints to further improve safety

Major Loosening Causes

- Loosening due to cyclic stress in the direction of the bolt axis
- Loosening due to cyclic stress in the direction perpendicular of the bolt axis

21. MINING EQUIPMENT



Pendulum Fastening for Vibration Screens

Before

- Conventinally, General Hex Nuts were used for fastening the Pendulum portion on the Vibration Screens.
- However, due to severe vibration, re-torquing work was performed at least once every 45 days.

After

- By switching to HARDLOCK Nut, re-torquing work was reduced to only once in over a years time.
- The plants operating rate and productivity was dramatically improved, along with a significant reduction in maintenance and labor costs

Major Loosening Cause

- Loosening due to cyclic stress in the direction perpendicular of the bolts axis



Safety is Power

HARDLOCK Industry Co., Ltd.

Head Office : 1-6-24, Kawamata, Higashi-Osaka, Osaka, Japan 577-0063

TEL : +81-6-6784-1131 FAX : +81-6-6784-1161

Tokyo Office : 2-5-9, Higashi-Ueno, Taito, Tokyo, Japan 110-0015

TEL : +81-3-3833-1491 FAX : +81-3-3833-1438

URL : <http://www.hardlock.co.jp/> E-mail : h.office@hardlock.co.jp